

SILVERTHINSK6-16NZ

Internal Gear Slewing Ring Bearing

Overall Dimensions

Outside diameter of outer ring (D_o)	20.390 in
Internal diameter on outer ring (D_i)	16.339 in
External diameter on outer ring (D_r)	17.870 in
Inside diameter of inner ring (d_i)	12.850 in
External diameter on inner ring (d_o)	16.260 in
Approximate Weight	65.00 lbs

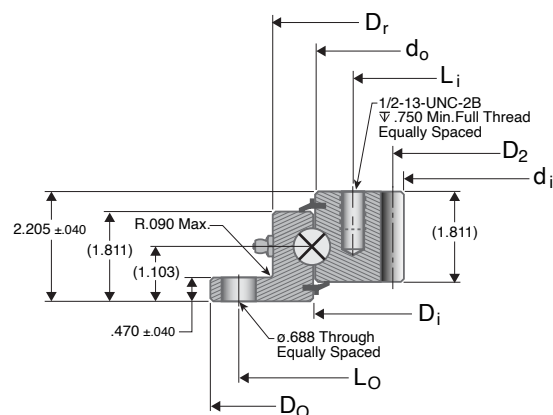

Gear Data ($\alpha = 20^\circ$)

Pitch diameter of gear (D_2)	13.250 in
Diametral pitch (P_d)	4
Max Gear Tooth Load (F_2)	6,800 lbs
Number of Teeth (Z_2)	53

Also Available

14 SD Tooth Mating Pinion	SP1629-14
17 SD Tooth Mating Pinion	SP1629-17

Interchange

Rotek	L6-16N9Z Avon	716 MB1 Kaydon	RK6-16N1Z
-------	---------------	----------------	-----------

Mounting Holes

Inner Ring Bolt Circle (L_i)	14.880 in
Inner Ring Hole Count	12
Outer Ring Bolt Circle (L_o)	19.250 in
Outer Ring Hole Count	8

Load Capacities

Moment Rating	23,300 ft-lbs
---------------	---------------