

SILVERTHINSK6-22NZ

Internal Gear Slewing Ring Bearing

Overall Dimensions

Outside diameter of outer ring (D_o)	25.510 in
Internal diameter on outer ring (D_i)	21.340 in
External diameter on outer ring (D_r)	22.990 in
Inside diameter of inner ring (d_i)	17.600 in
External diameter on inner ring (d_o)	21.260 in
Approximate Weight	90.00 lbs

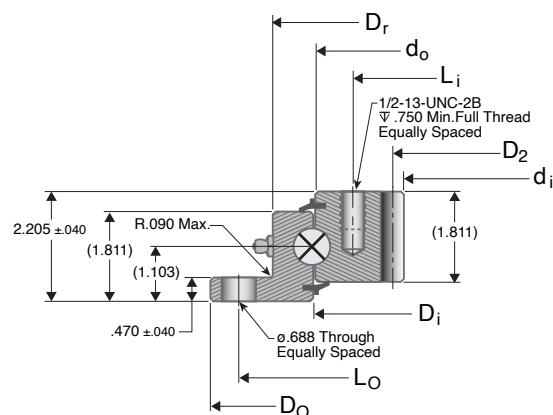

Gear Data ($\alpha = 20^\circ$)

Pitch diameter of gear (D_2)	18.000 in
Diametral pitch (P_d)	4
Max Gear Tooth Load (F_2)	6,530 lbs
Number of Teeth (Z_2)	72

Also Available

14 SD Tooth Mating Pinion	SP1629-14
17 SD Tooth Mating Pinion	SP1629-17

Interchange

Rotek	L6-22N9Z Avon	721 MB1 Kaydon	RK6-22N1Z
-------	---------------	----------------	-----------

Mounting Holes

Inner Ring Bolt Circle (L_i)	19.630 in
Inner Ring Hole Count	15
Outer Ring Bolt Circle (L_o)	24.380 in
Outer Ring Hole Count	10

Load Capacities

Moment Rating	33,630 ft-lbs
---------------	---------------