

SILVERTHINSK6-25NZ

Internal Gear Slewing Ring Bearing

Overall Dimensions

Outside diameter of outer ring (D_o)	29.450 in
Internal diameter on outer ring (D_i)	25.280 in
External diameter on outer ring (D_r)	26.930 in
Inside diameter of inner ring (d_i)	21.600 in
External diameter on inner ring (d_o)	25.200 in
Approximate Weight	106.00 lbs

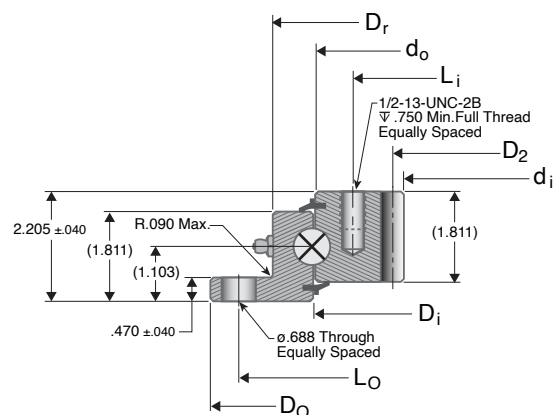

Gear Data ($\alpha = 20^\circ$)

Pitch diameter of gear (D_2)	22.000 in
Diametral pitch (P_d)	4
Max Gear Tooth Load (F_2)	6,400 lbs
Number of Teeth (Z_2)	88

Also Available

14 SD Tooth Mating Pinion	SP1629-14
17 SD Tooth Mating Pinion	SP1629-17

Interchange

Rotek	L6-25N9Z Avon	725 MB1 Kaydon	RK6-25N1Z
-------	---------------	----------------	-----------

Mounting Holes

Inner Ring Bolt Circle (L_i)	23.630 in
Inner Ring Hole Count	18
Outer Ring Bolt Circle (L_o)	28.380 in
Outer Ring Hole Count	12

Load Capacities

Moment Rating	50,150 ft-lbs
---------------	---------------