

SILVERTHINSK6-29NZ

Internal Gear Slewing Ring Bearing

Overall Dimensions

Outside diameter of outer ring (D_o)	33.390 in
Internal diameter on outer ring (D_i)	29.213 in
External diameter on outer ring (D_r)	30.870 in
Inside diameter of inner ring (d_i)	25.600 in
External diameter on inner ring (d_o)	29.134 in
Approximate Weight	121.00 lbs

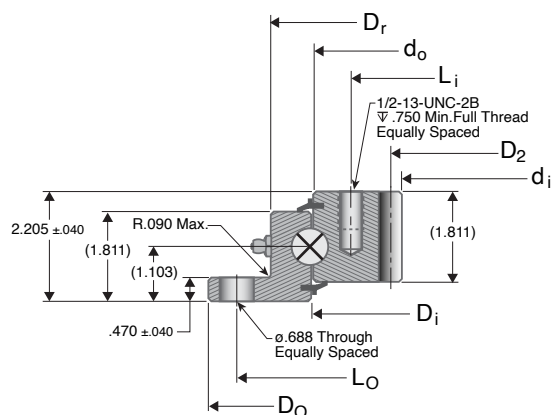

Gear Data ($\alpha = 20^\circ$)

Pitch diameter of gear (D_2)	26.000 in
Diametral pitch (P_d)	4
Max Gear Tooth Load (F_2)	6,300 lbs
Number of Teeth (Z_2)	104

Also Available

14 SD Tooth Mating Pinion	SP1629-14
17 SD Tooth Mating Pinion	SP1629-17

Interchange

Rotek	L6-29N9Z Avon	729 MB1 Kaydon	RK6-29N1Z
-------	---------------	----------------	-----------

Mounting Holes

Inner Ring Bolt Circle (L_i)	27.630 in
Inner Ring Hole Count	18
Outer Ring Bolt Circle (L_o)	32.250 in
Outer Ring Hole Count	15

Load Capacities

Moment Rating	53,100 ft-lbs
---------------	---------------