

SILVERTHINSK6-33NZ

Internal Gear Slewing Ring Bearing

Overall Dimensions

Outside diameter of outer ring (D_o)	37.320 in
Internal diameter on outer ring (D_i)	33.150 in
External diameter on outer ring (D_r)	34.800 in
Inside diameter of inner ring (d_i)	29.133 in
External diameter on inner ring (d_o)	33.070 in
Approximate Weight	148.00 lbs

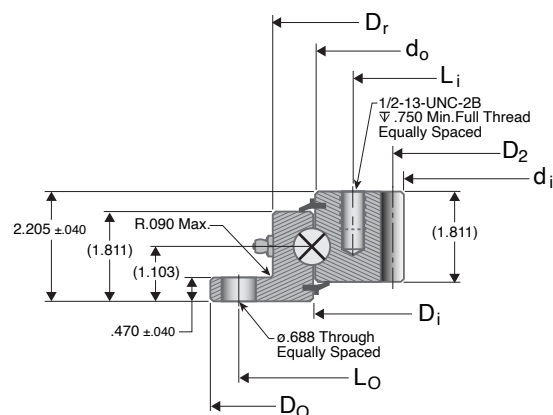

Gear Data ($\alpha = 20^\circ$)

Pitch diameter of gear (D_2)	29.667 in
Diametral pitch (P_d)	3
Max Gear Tooth Load (F_2)	8,520 lbs
Number of Teeth (Z_2)	89

Also Available

14 SD Tooth Mating Pinion	SP3343-14
17 SD Tooth Mating Pinion	SP3343-17

Interchange

Rotek	L6-33N9Z Avon	733 MB1 Kaydon	RK6-33N1Z
-------	---------------	----------------	-----------

Mounting Holes

Inner Ring Bolt Circle (L_i)	31.500 in
Inner Ring Hole Count	18
Outer Ring Bolt Circle (L_o)	36.250 in
Outer Ring Hole Count	18

Load Capacities

Moment Rating	57,400 ft-lbs
---------------	---------------